

# Makita

アメリカ

## Cordless Impact Driver

**MODEL 6901D**  
**MODEL 6901DW**  
With Fast Charger

### INSTRUCTION MANUAL



#### SPECIFICATIONS

• Model 6901D

Capacities	No load speed (RPM)	Impacts per minute	Max. tightening torque (Note 1)	Dimensions (L x W x H)	Net weight
Machine screw and bolt					
5 mm – 10 mm (3/16" – 3/8")	2,200	2,800	700 kg · cm (50 ft · lbs)	199 mm x 58 mm x 212 mm (7-13/16" x 2-5/16" x 8-3/8")	1.3 kg (2.9 lbs)

• Battery Cartridge 9100

• Model DC9700 Fast Charger

Voltage	Charging time	Input	Output
9.6 V	1 Hr.	A.C. only 50 Hz – 60 Hz	D.C. 7.2 V, 9.6 V

Note 1. After tightening high tensile bolt M10F11T for 3 seconds while using a fully charged battery cartridge.

• Manufacturer reserves the right to change specifications without notice.

• Note: Specifications may differ from country to country.

# **IMPORTANT SAFETY INSTRUCTIONS**

**(For All Tools)**

**WARNING: WHEN USING ELECTRIC TOOLS, BASIC SAFETY PRECAUTIONS SHOULD ALWAYS BE FOLLOWED TO REDUCE THE RISK OF FIRE, ELECTRIC SHOCK, AND PERSONAL INJURY, INCLUDING THE FOLLOWING:**

## **READ ALL INSTRUCTIONS.**

1. **KEEP WORK AREA CLEAN.** Cluttered areas and benches invite injuries.
2. **CONSIDER WORK AREA ENVIRONMENT.** Don't use power tools in damp or wet locations. Keep work area well lit. Don't expose power tools to rain. Don't use tool in presence of flammable liquids or gases.
3. **KEEP CHILDREN AWAY.** All visitors should be kept away from work area. Don't let visitors contact tool or extension cord.
4. **STORE IDLE TOOLS.** When not in use, tools should be stored in dry, and high or locked-up place — out of reach of children.
5. **DON'T FORCE TOOL.** It will do the job better and safer at the rate for which it was intended.
6. **USE RIGHT TOOL.** Don't force small tool or attachment to do the job of a heavy-duty tool. Don't use tool for purpose not intended.
7. **DRESS PROPERLY.** Don't wear loose clothing or jewelry. They can be caught in moving parts. Rubber gloves and non-skid footwear are recommended when working outdoors. Wear protective hair covering to contain long hair.
8. **USE SAFETY GLASSES.** Also use face or dust mask if cutting operation is dusty.
9. **DON'T ABUSE CORD.** Never carry tool by cord or yank it to disconnect from receptacle. Keep cord from heat, oil, and sharp edges.
10. **SECURE WORK.** Use clamps or a vise to hold work. It's safer than using your hand and it frees both hands to operate tool.
11. **DON'T OVERREACH.** Keep proper footing and balance at all times.
12. **MAINTAIN TOOLS WITH CARE.** Keep tools sharp and clean for better and safer performance. Follow instructions for lubricating and changing accessories. Inspect tool cords periodically and if damaged, have repaired by authorized service facility. Inspect extension cords periodically and replace if damaged. Keep handles dry, clean, and free from oil and grease.
13. **DISCONNECT TOOLS.** When not in use, before servicing, and when changing accessories, such as blades, bits, cutters.

14. **REMOVE ADJUSTING KEYS AND WRENCHES.** Form habit of checking to see that keys and adjusting wrenches are removed from tool before turning it on.
15. **AVOID UNINTENTIONAL STARTING.** Don't carry plugged-in tool with finger on switch. Be sure switch is OFF when plugging in.
16. **OUTDOOR USE EXTENSION CORDS.** When tool is used outdoors, use only extension cords intended for use outdoors and so marked.
17. **STAY ALERT.** Watch what you are doing, use common sense. Don't operate tool when you are tired.
18. **CHECK DAMAGED PARTS.** Before further use of the tool, a guard or other part that is damaged should be carefully checked to determine that it will operate properly and perform its intended function. Check for alignment of moving parts, binding of moving parts, breakage of parts, mounting, and any other conditions that may affect its operation. A guard or other part that is damaged should be properly repaired or replaced by an authorized service center unless otherwise indicated elsewhere in this instruction manual. Have defective switches replaced by authorized service center. Don't use tool if switch does not turn it on and off.
19. **GUARD AGAINST ELECTRIC SHOCK.** Prevent body contact with grounded surfaces. For example; pipes, radiators, ranges, refrigerator enclosures.
20. **REPLACEMENT PARTS.** When servicing, use only identical replacement parts.

**VOLTAGE WARNING:** Before connecting the tool to a power source (receptacle, outlet, etc.) be sure the voltage supplied is the same as that specified on the nameplate of the tool. A power source with voltage greater than that specified for the tool can result in **SERIOUS INJURY** to the user — as well as damage to the tool. If in doubt, **DO NOT PLUG IN THE TOOL.** Using a power source with voltage less than the nameplate rating is harmful to the motor.

# IMPORTANT SAFETY INSTRUCTIONS

1. **SAVE THESE INSTRUCTIONS** – This manual contains important safety and operating instructions for battery charger.
2. Before using battery charger, read all instructions and cautionary markings on (1) battery charger, (2) battery, and (3) product using battery.
3. **CAUTION** – To reduce risk of injury, charge only MAKITA Battery 7000, 9000 or 9100. Other types of batteries may burst causing personal injury and damage.
4. Do not expose charger to rain or snow.
5. Use of an attachment not recommended or sold by the battery charger manufacturer may result in a risk of fire, electric shock, or injury to persons.
6. To reduce risk of damage to electric plug and cord, pull by plug rather than cord when disconnecting charger.
7. Make sure cord is located so that it will not be stepped on, tripped over, or otherwise subjected to damage or stress.
8. An extension cord should not be used unless absolutely necessary. Use of improper extension cord could result in a risk of fire and electric shock. If extension cord must be used, make sure:
  - a. That pins on plug of extension cord are the same number, size, and shape as those of plug on charger;
  - b. That extension cord is properly wired and in good electrical condition; and
  - c. That wire size is at least as large as the one specified in the table below.

**TABLE 1**  
**RECOMMENDED MINIMUM AWG SIZE FOR**  
**EXTENSION CORDS FOR BATTERY CHARGERS**

Length of Cord (Feet)	25	50	100	150
AWG Size of Cord	18	18	18	16

9. Do not operate charger with damaged cord or plug – replace them immediately.
10. Do not operate charger if it has received a sharp blow, been dropped, or otherwise damaged in any way; take it to a qualified serviceman.
11. Do not disassemble charger or battery cartridge; take it to a qualified serviceman when service or repair is required. Incorrect reassembly may result in a risk of electric shock or fire.
12. To reduce risk of electric shock, unplug charger from outlet before attempting any maintenance or cleaning. Turning off controls will not reduce this risk.

## **ADDITIONAL SAFETY RULES FOR CHARGER & BATTERY CARTRIDGE**

1. Do not charge Battery Cartridge when temperature is BELOW 10°C (50°F) or ABOVE 40°C (104°F).
2. Do not attempt to use a step-up transformer, an engine generator or DC power receptacle.
3. Do not allow anything to cover or clog the charger vents.
4. Do not short the battery cartridge:
  - (1) Do not touch the terminals with any conductive material.
  - (2) Avoid storing battery cartridge in a container with other metal objects such as nails, coins, etc.
  - (3) Do not expose battery cartridge to water or rain.

A battery short can cause a large current flow, overheating, possible burns and even a breakdown.
5. Do not store the tool and Battery Cartridge in locations where the temperature may reach or exceed 50°C (122°F).
6. Do not incinerate the Battery Cartridge even if it is severely damaged or is completely worn out. The battery cartridge can explode in a fire.

## **ADDITIONAL SAFETY RULES**

1. Be aware that this tool is always in an operating condition, because it does not have to be plugged into an electrical outlet.
2. Wear ear protectors.
3. Hold the tool firmly.
4. Always be sure you have a firm footing.

Be sure no one is below when using the tool in high locations.
5. When driving into walls, floors or wherever "live" electrical wires may be encountered, **DO NOT TOUCH ANY METAL PARTS OF THE TOOL!**

Hold the tool only by the insulated grasping surfaces to prevent electric shock if you drive into a "live" wire.

**SAVE THESE INSTRUCTIONS.**

## Installing or removing battery cartridge

- Always switch off the tool before insertion or removal of the battery cartridge.
- To remove the battery cartridge, pull out the set plate and grasp both sides of the cartridge while withdrawing it from the tool.
- To install the battery cartridge, insert the battery cartridge into the housing and snap the set plate back into place. Be sure to close the set plate fully before using the tool.

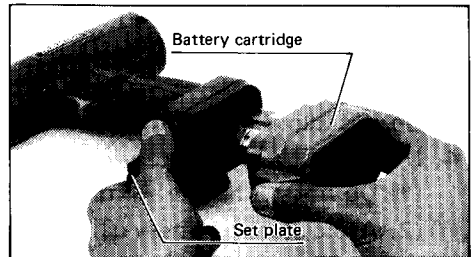

## Charging

Plug the fast charger into your power source. Insert the battery cartridge so that the plus and minus terminals on the battery cartridge are on the same sides as their respective markings on the fast charger. Insert the cartridge fully into the port so that it rests on the charger port floor.

Press the start button (red). The charging light will come on and charging will begin.

If the charging light does not come on, press the reset button (yellow) first, then the start button (red).

If the charging light goes out within 10 seconds even after pressing the reset button and start button a couple of times, the battery cartridge is dead. (CAUTION: Wait for more than 5 seconds after the charging light goes out to press the reset button again.) Replace it with a new one. When the charging light goes out after about one hour, you may remove the fully charged battery cartridge.

After charging, unplug the charger from the power source.

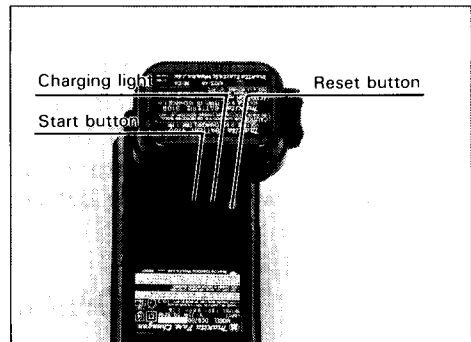

## CAUTION:

- Your new battery cartridge is not charged. You will need to charge it before use.
- Do not keep the button pressed in with tape, etc. or the circuit will not function properly. Also, a malfunction of the charger may result possibly causing overheating, etc.
- If you try to charge a cartridge from a just-operated tool, sometimes the charging light will not come on. If this occurs, let the cartridge cool off for a while. Then re-insert it and try to charge it once more.
- When you charge a new battery cartridge or a battery cartridge which has not been used for a long period, it may not accept a full charge. This is a normal condition and does not indicate a problem. You can recharge the battery cartridge fully after discharging it almost completely a couple of times.
- If you wish to charge two battery cartridges, allow 15 minutes between chargings on the fast charger.

### Installing or removing driver bit

#### CAUTION:

Always be sure that the tool is switched off and the battery cartridge is removed before installing or removing the bit.

Slide the sleeve toward the motor and insert the bit into the sleeve as far as it will go. Then release the sleeve to secure the bit.

To remove the bit, slide the sleeve toward the motor and pull the bit out firmly.

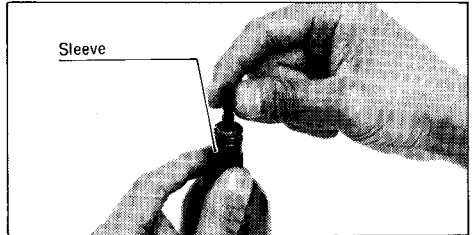

#### NOTE:

If the bit is not inserted deep enough into the sleeve, the sleeve will not return to its original position and the bit will not be secured. In this case, try re-inserting the bit according to the instructions above.

### Switch action

To start the tool, simply pull the trigger. Release the trigger to stop.

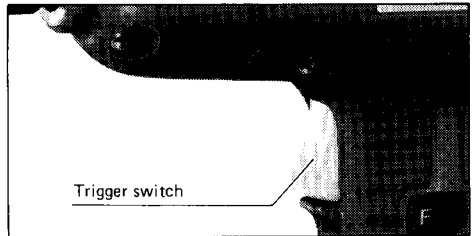

#### CAUTION:

Before inserting the battery cartridge into the tool, always check to see that the trigger switch actuates properly and returns to the "OFF" position when released.

### Reversing switch action

This tool has a reversing switch to change the direction of rotation. Slide the reversing switch to the right for clockwise rotation or to the left for counterclockwise.

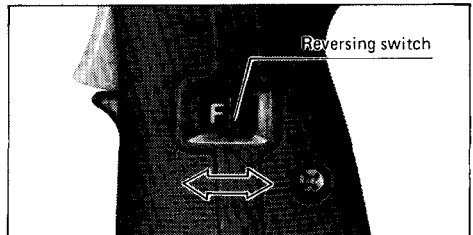

#### CAUTION:

- Always check the direction of rotation before operation.
- Use the reversing switch only when the tool comes to a complete stop. Changing the direction of rotation before the tool stops may ruin the tool.

### Operation

The proper tightening torque may differ depending upon the kind or size of the screw, the material of the workpiece to be tightened, etc. The relation between tightening torque and tightening time is shown in the figures below.

#### Machine screw

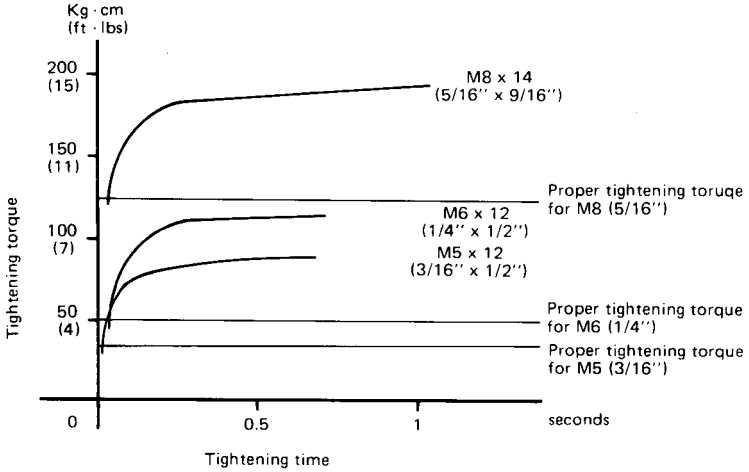

#### Standard bolt

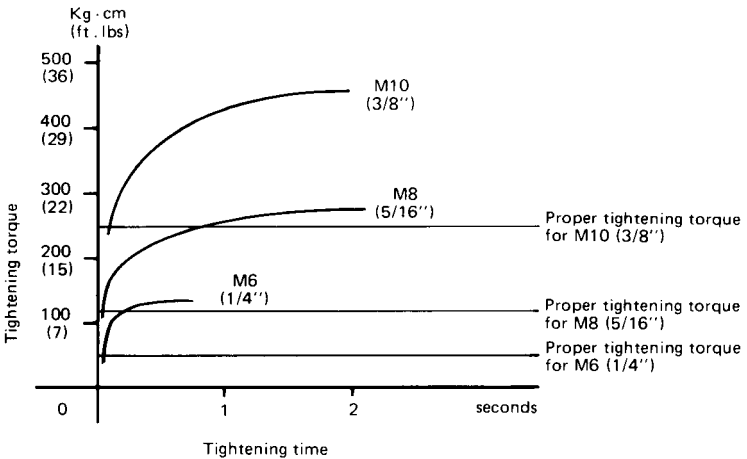



Hold the tool firmly and place the point of the driver bit in the screw head. Apply forward pressure to the tool to the extent that the bit will not slip off the screw and turn the tool on to start operation.

**NOTE:**

- Use the proper bit for the head of the screw that you wish to use.
- Hold the tool pointed straight at the screw.
- If you tighten the screw for a time longer than shown in the figures above, the screw or the point of the driver bit may be overstressed, stripped, damaged, etc. Before starting your job, always perform a test operation to determine the proper tightening time for your screw. When tightening a standard screw in a steel plate, the proper tightening torque can be obtained in an extremely short time (approx. 0.1 -- 0.2 seconds). Turn the tool off as soon as the impact sound is heard.

The tightening torque is affected by a wide variety of factors including the following. After tightening, always check the torque with a torque wrench.

1. When the battery cartridge is discharged almost completely, voltage will drop and the tightening torque will be reduced.
2. Driver bit or socket bit
  - \* Failure to use the correct size driver bit or socket bit will cause a reduction in the tightening torque.
3. Bolt
  - \* Even though the torque coefficient and the class of bolt are the same, the proper tightening torque will differ according to the diameter of bolt.
  - \* Even though the diameters of bolts are the same, the proper tightening torque will differ according to the torque coefficient, the class of bolt and the bolt length.
4. The manner of holding the tool or the material of driving position to be tightened will affect the torque.

**CAUTION:**

If the tool is operated continuously until the battery cartridge has discharged, allow the tool to rest for 15 minutes before proceeding with a fresh battery.

## **MAINTENANCE**

### **CAUTION:**

Always be sure that the tool is switched off and the battery cartridge is removed before attempting to perform inspection or maintenance.

To maintain product **SAFETY** and **RELIABILITY**, repairs, maintenance or adjustment should be performed by Makita Authorized or Factory Service Centers, always using Makita replacement parts.

# ACCESSORIES

## CAUTION:

These accessories or attachments are recommended for use with your Makita tool specified in this manual. The use of any other accessories or attachments might present a risk of injury to persons. The accessories or attachments should be used only in the proper and intended manner.

### • Bits

	Size	Part No.
Phillips	#2	784214-0A
	#3	784215-0A

### • Keyless drill chuck

Part No. 192048-7



### • Steel carrying case

Part No. 182132-6



### • Fast charger

Model DC9700

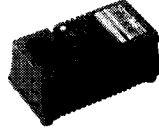

### • Charger 12V for car

Model DC9112



### • Battery cartridge 9100

Part No. 192019-4



# CORDLESS IMPACT DRIVER

## Model 6901D

**Type1**

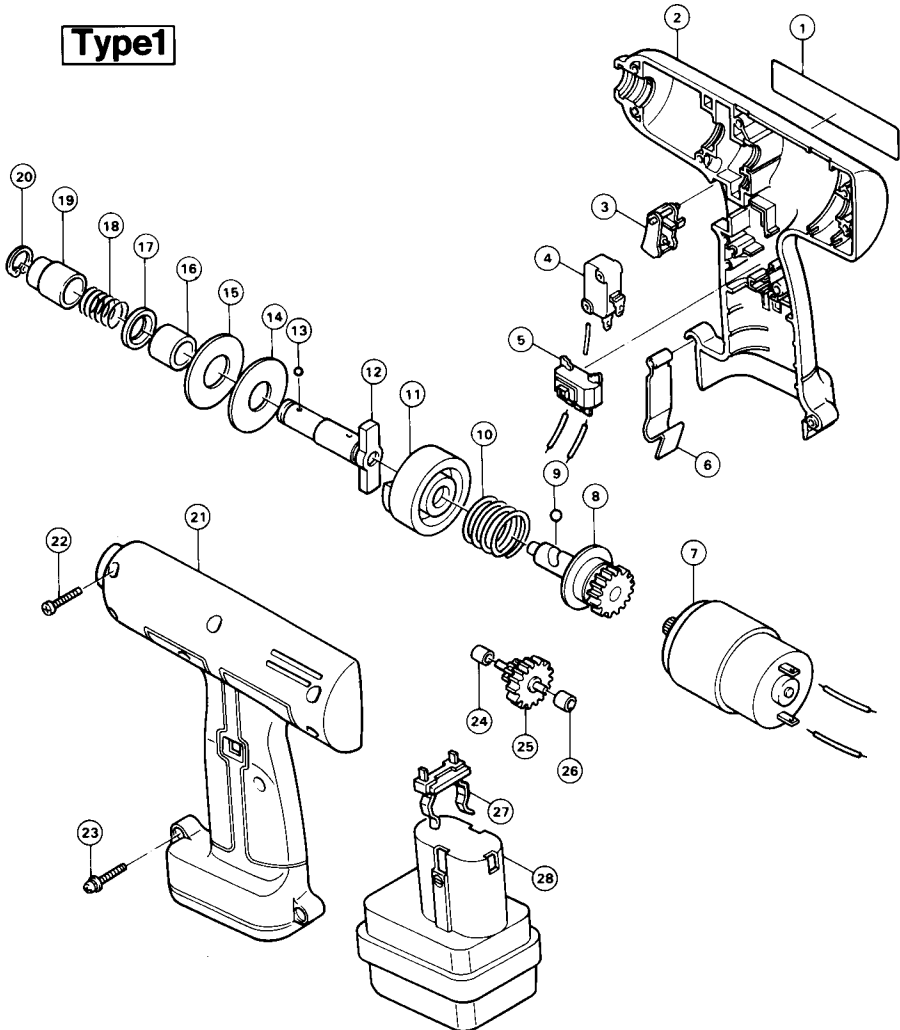

Note: The switch and other part configurations may differ from country to country.

ITEM NO.	NO. USED	DESCRIPTION	ITEM NO.	NO. USED	DESCRIPTION
<u>MACHINE</u>			<u>MACHINE</u>		
1	1	Name Plate	15	1	Rubber Washer 20
2	1	Housing Set (With Item 21)	16	1	Sleeve 14
3	1	Switch Lever	17	1	Oil Seal 14
4	1	Switch	18	1	Compression Spring 13
5	1	Switch	19	1	Sleeve
6	1	Set Plate	20	1	Retaining Ring S-12
7	1	DC Motor 9.6 V.	21	1	Housing Set (With Item 2)
8	1	Spindle	22	8	Tapping Screw 4x20
9	2	Steel Ball 5.6	23	1	Pan Head Screw M4x20 (With Washer)
10	1	Compression Spring 24	24	1	Plane Bearing 4
11	1	Hammer	25	1	Gear Complete 15-51
12	1	Anvil	26	1	Plane Bearing 4
13	1	Steel Ball 3.5	27	1	Battery Holder
14	1	Flat Washer 14	28	1	Battery 9100

Note: The switch and other part specifications may differ from country to country.



## MAKITA LIMITED ONE YEAR WARRANTY

### Warranty Policy

Every Makita tool is thoroughly inspected and tested before leaving the factory. It is warranted to be free of defects from workmanship and materials for the period of ONE YEAR from the date of original purchase. Should any trouble develop during this one-year period, return the COMPLETE tool, freight prepaid, to one of Makita's Factory or Authorized Service Centers. If inspection shows the trouble is caused by defective workmanship or material, Makita will repair (or at our option, replace) without charge.

This Warranty does not apply where:

- repairs have been made or attempted by others;
- repairs are required because of normal wear and tear;
- The tool has been abused, misused or improperly maintained;
- alterations have been made to the tool.

IN NO EVENT SHALL MAKITA BE LIABLE FOR ANY INDIRECT, INCIDENTAL OR CONSEQUENTIAL DAMAGES FROM THE SALE OR USE OF THE PRODUCT. THIS DISCLAIMER APPLIES BOTH DURING AND AFTER THE TERM OF THIS WARRANTY.

MAKITA DISCLAIMS LIABILITY FOR ANY IMPLIED WARRANTIES, INCLUDING IMPLIED WARRANTIES OF "MERCHANTABILITY" AND "FITNESS FOR A SPECIFIC PURPOSE," AFTER THE ONE-YEAR TERM OF THIS WARRANTY.

This Warranty gives you specific legal rights, and you may also have other rights which vary from state to state. Some states do not allow the exclusion or limitation of incidental or consequential damages, so the above limitation or exclusion may not apply to you. Some states do not allow limitation on how long an implied warranty lasts, so the above limitation may not apply to you.

**Makita Corporation**

3-11-8, Sumiyoshi-cho,  
Anjo, Aichi 446 Japan

883683C061

PRINTED IN JAPAN  
1991 - 10 - N